



PELLASX[®]

PRODUCT CATALOGUE
2023

ABOUT US

We have been developing advanced heating system technology since 1992. We manufactured our first pellet burners in 2001. All our products are designed by our qualified and experienced design team and the highest quality of production is ensured by a well-equipped and continuously modernized machinery. **PellasX** is the brand name we use to manufacture burners for a wide range of industrial, agricultural, production and residential heating applications. Such a wide array of applications shows our determination and perseverance in the constant strive for development. We are not afraid of challenges and are committed to creating the technology that will serve the future of the industry. We cooperate with scientific and research institutions. The results of this work are some of the most advanced burners in the world. Constantly expanded analytical and research capacities of our **Research and Development Department** result not only in new, perfectly optimised and reliable burners, but also provide the possibility to certify boilers equipped with **PellasX** burners in our laboratory.



This is how **PellasX** has grown from a manufacturing company to a supplier of complete pellet technology in the power range up to **1MW**. With over twenty years of experience, our research facilities and the precisely designed technology employed in our burners, we effectively support boiler manufacturers in the certification process of their equipment

With our support, achieving the lowest levels of waste gas and dust emissions, including those regulated by foreign standards, is no longer a problem.

We support and train installers and grant certification and authorization for the sale, installation, commissioning and inspection of **PellasX** burners.

JOIN THE RANKS OF THE PROFESSIONALS - BENEFIT FROM THE LATEST TECHNOLOGY

MISSION

The company's mission is to promote environmentally friendly sources of renewable energy, which we achieve by developing biomass combustion technology. Our aim is to strive for technological harmony combining ecological, efficient and user-friendly solutions. We continue to implement innovative technological solutions by incorporating new systems into our equipment. A continuous process of research and optimisation ensures that, despite changing times and trends, we can easily adapt to the new market needs. Proof of our technological mission is the ever-increasing trust of our customers, which has resulted in the following achievements over the past 20 years:

More than 40,000 PellasX devices are in operation worldwide

21 awards and distinctions

40 countries of collaboration

46 qualified employees

QUALITY POLICY

We are observing the changing quality of available fuels made from biomass. Our objective is to meet the new challenges associated with the combustion of solid fuels, also from those raw materials that are just emerging in this role. We perform each of our activities with this goal in mind, taking trust, partnership and customer satisfaction as our ultimate objectives.

Base for our development is the work based on:

- Highest quality of equipment
- Product improvement
- High quality of materials and components
- Qualified staff
- Continuous modernization of our machinery
- Analyses of heating equipment market development

PELLASX BURNERS MADE IN POLAND, INSTALLED ALL OVER THE WORLD!



X LINE

POWER RANGE 26 - 500kW

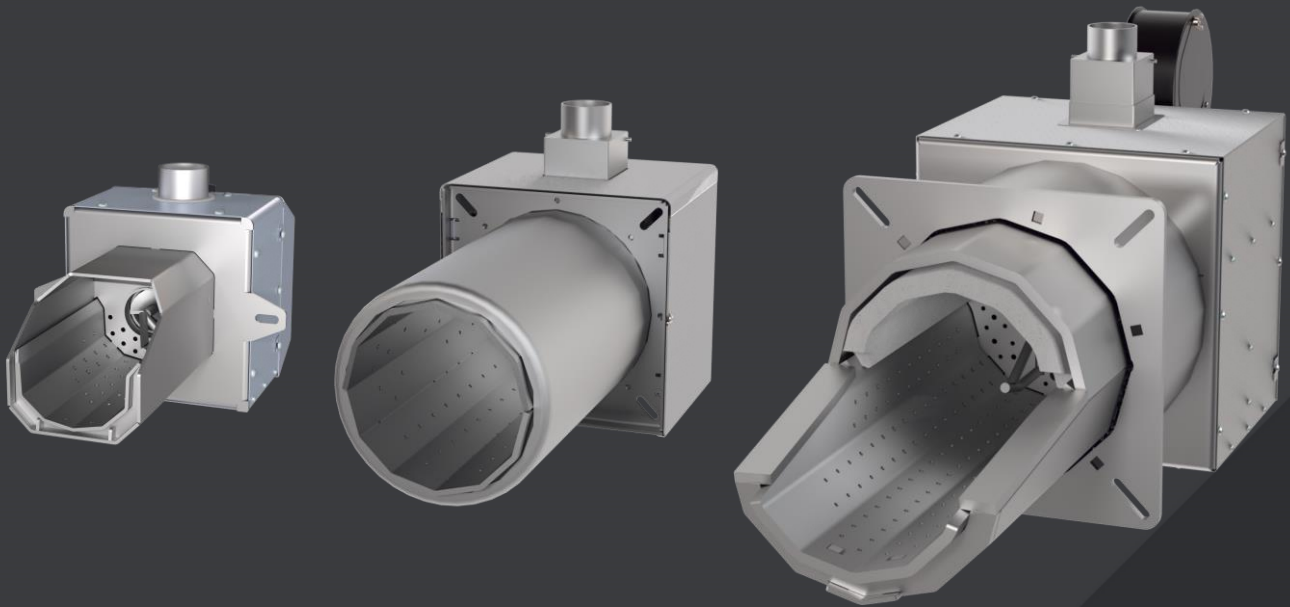

This is the longest-developed line of equipment manufactured by PellasX. The qualities that set them apart are robustness and reliability. At the same time, it is the line with the widest power range. The burners are equipped with a **FUEL MIXING SYSTEM**, **OVERPRESSURE COMBUSTION SYSTEM** and **X.GNITE** quick ignition system.

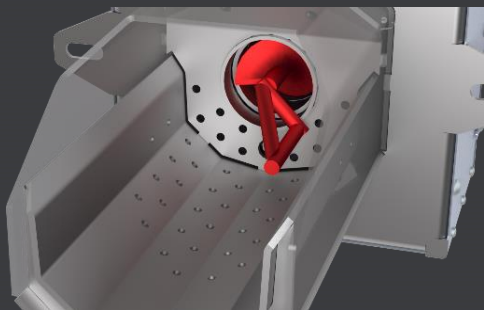

FUEL MIXING SYSTEM

is based on an internal feeder that doses the correct amount of pellets into the combustion chamber while mixing the fuel in the furnace. This optimises the combustion process. The function ensures extended maintenance-free operation of the burner when burning pellets with a high ash content.

OVERPRESSURE COMBUSTION SYSTEM

improves the efficiency of pellet combustion. The air supplied at the centre of the PellasX burner furnace enhances flame swirl, and the use of a Venturi tube reduces the possibility of flashback.

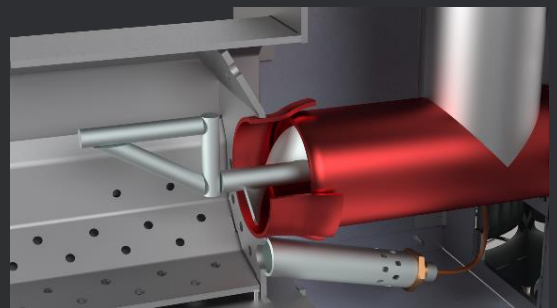

X.GNITE SYSTEM

is a combination of the durability of metal igniters and the ignition rate of ceramic igniters. The result is the reduced electricity consumption and shorter time required to start the burner.

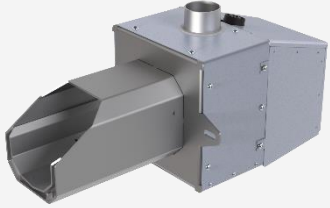
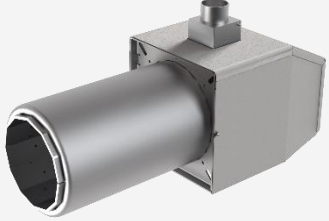
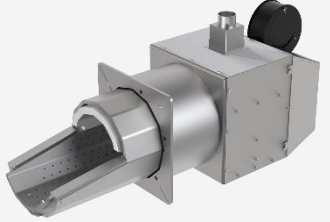
SYSTEMS	 X26 - 35 kW	 X44 - 150 kW	 X190 - 500 kW
FUEL MIXING SYSTEM	✓	✓	✓
OVERPRESSURE COMBUSTION SYSTEM	✓	✓	✓
FUEL INLET FIREWALL SYSTEM	-	✓	✓
X.GNITE SYSTEM	✓	✓	✓
FIREPROOF CERAMICS	-	-	✓

HYBRID LINE

POWER RANGE 16 - 35kW

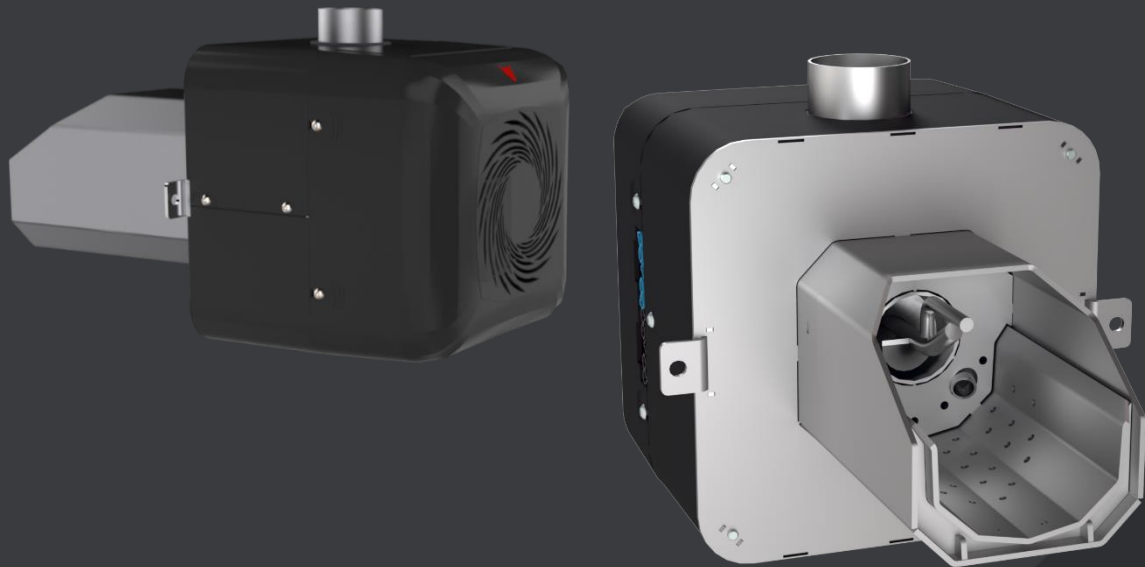

It is the result of equipping the X line burners with technologies used in the more technologically advanced models of the REVO line. The innovative **HYBRID DRIVE SYSTEM** controls the balanced supply of air and fuel to the combustion chamber to reduce electricity consumption which results in lower emissions and stabilisation of combustion parameters. Solutions incorporated in the burner include **FUEL INLET FIREWALL SYSTEM** and the **X.BOARD SYSTEM**.

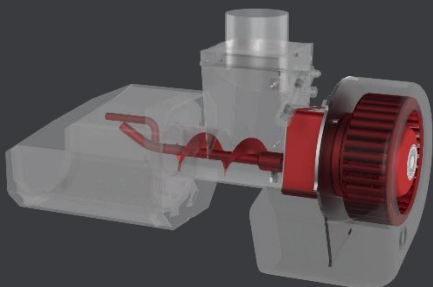

HYBRID DRIVE SYSTEM

Its task is to supply fuel and air to the combustion chamber using a single motor equipped with a **Hallsensor**. With this solution, we have optimised the precise metering of the pellet-air mixture so that the combustion process runs efficiently with the lowest possible emissions.

X.SHELL SYSTEM

is an easily removable fan housing with an integrated blower duct. Its shape allows the full power range of the blower to be used.

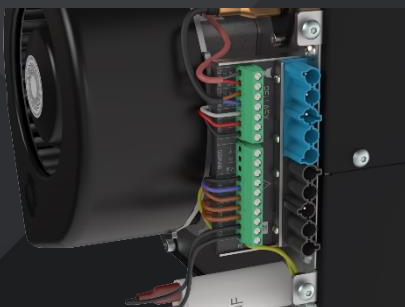
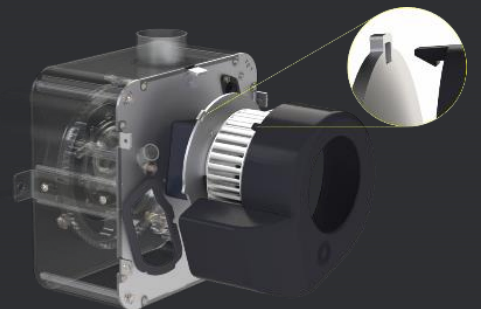

X.BOARD SYSTEM

is a proprietary combination of a safety plug and socket with the electrical system in the burner. It significantly simplifies and speeds up the installation and service of the PellasX burners.

HYBRID LINE

SYSTEMS	 H16 kW	 H26 kW	 H35 kW
HYBRID DRIVE SYSTEM	✓	✓	✓
FUEL INLET FIREWALL SYSTEM	✓	✓	✓
OVERPRESSURE COMBUSTION SYSTEM	✓	✓	✓
FUEL MIXING SYSTEM	✓	✓	✓
X.BOARD SYSTEM	✓	✓	✓
X.GNITE SYSTEM	✓	✓	✓
X.SHELL SYSTEM	✓	✓	✓

REVO LINE

POWER RANGE 16 - 35kW

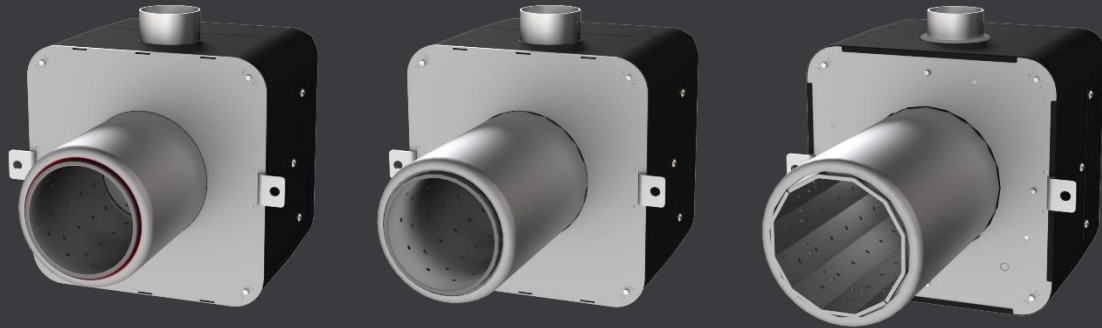

These are the most innovative burners of this design on the market. Their pioneering feature is the combination of rotary combustion chamber technology and the **HYBRID DRIVE SYSTEM**. In addition to high combustion efficiency of up to 99% and very low CO₂ emissions, burners of the **REVO** line stand out for their extremely effective furnace cleaning system. The combination of these features makes it almost unrivalled in its class.



ROTARY COMBUSTION CHAMBER SYSTEM

allows self-cleaning from ash and minimises the need to service the unit. On the R16 and R26 models, the chamber is made from PellasX's proprietary **InCroX®** high-chromium alloy. The bearings on which the combustion chamber rotates are positioned in such a way as to exclude the negative effects of high temperatures and to facilitate possible replacement.



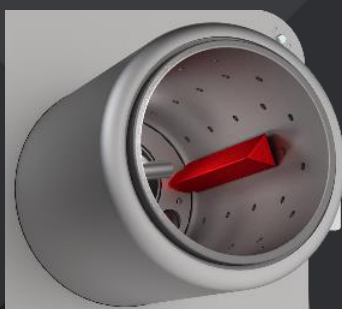
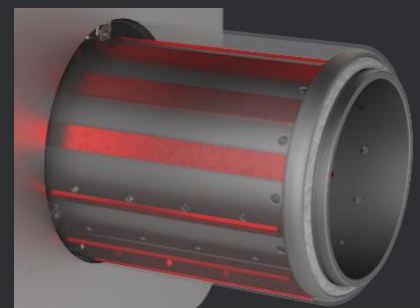

AIR VANE SYSTEM

directs air precisely to where combustion takes place and blocks the air flow in other areas, which increases the efficiency of the combustion process. This has resulted in combustion efficiency never achieved before and the fifth i.e. the highest class of waste gas emission.



SCRAPER

is a high-chromium **InCroX®** alloy combustion chamber surface cleaner. Available as an optional accessory for R16 and R26 burners. Allows cleaning of the inside of the rotating combustion chamber. Designed to operate under harsh conditions, i.e. burning ash-rich fuels that tend to form sinter.

			
SYSTEMS	R16 kW	R26 kW	R35 kW
ROTARY COMBUSTION CHAMBER SYSTEM	✓	✓	✓
INCROX® HIGH-CHROMIUM ALLOY	✓	✓	⊖
FUEL INLET FIREWALL SYSTEM	✓	✓	⊖
SCRAPER			⊖
HYBRID DRIVE SYSTEM	✓	✓	✓
AIR VANE SYSTEM	✓	✓	✓
OVERPRESSURE COMBUSTION SYSTEM	✓	✓	✓
FLOATING PIPE SYSTEM	⊖	⊖	✓
X.BOARD SYSTEM	✓	✓	⊖
X.SHELL SYSTEM	✓	✓	✓
X.GNITE SYSTEM	✓	✓	✓

 SCRAPER is an optional accessory

MOTION LINE

POWER RANGE 16 - 500kW

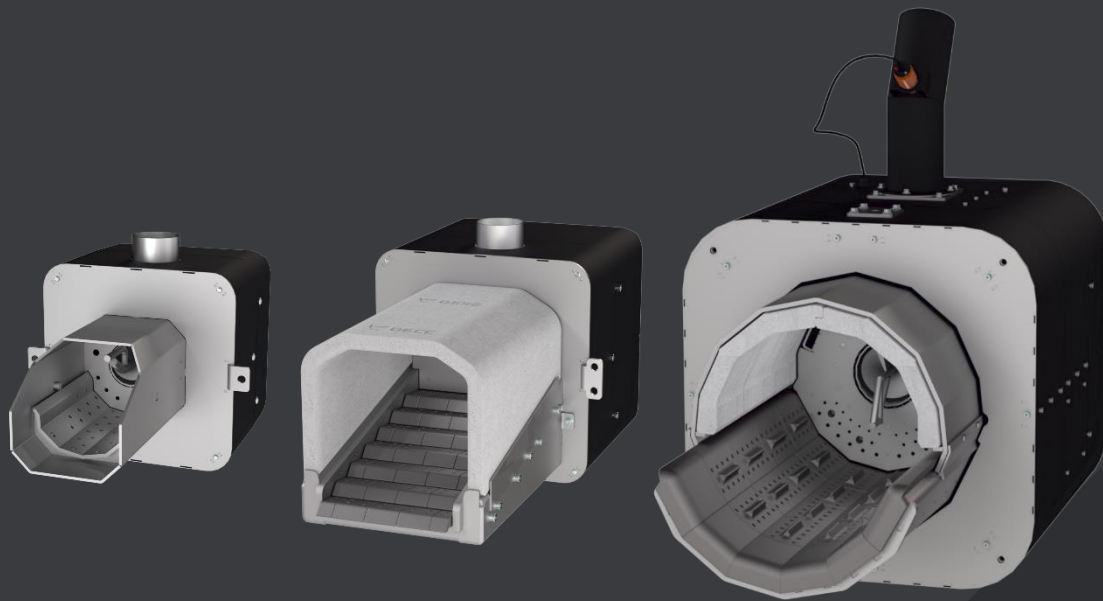

The **MOTION** line represents the most sophisticated combination of the **FUEL MIXING SYSTEM** employed in **X** line burners and the **HYBRID DRIVE SYSTEM** used in the **HYBRID** line with the **SINGLE STAGE GRATE SYSTEM**. The simultaneous operation of the three revolutionary solutions enables a longer maintenance-free burner life and the combustion of low-quality pellets.

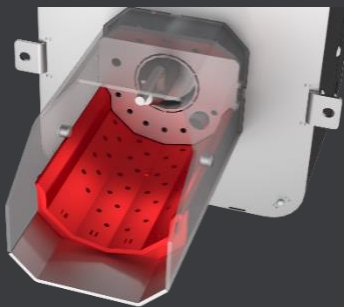

SINGLE STAGE GRATE SYSTEM

allows sinter and ash produced in the combustion process to be moved forward to ensure continuous cleaning of the combustion chamber during the operation of the burner. Allows efficient combustion of low-quality pellets.

MULTI-STAGE GRATE / WALKING GRATE SYSTEM

is a modular, movable furnace made of high-chromium **InCroX®** alloy which prevents cracking and increases the life of the furnace in high-power burners.



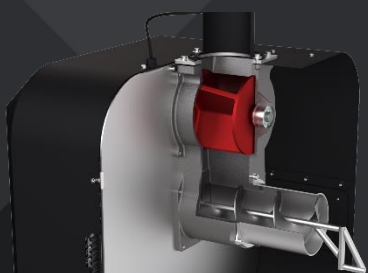

CELL FUEL DOSING SYSTEM

ensures high accuracy of fuel feeding to the burner while maintaining high level of burner operation safety - prevents flashbacks.

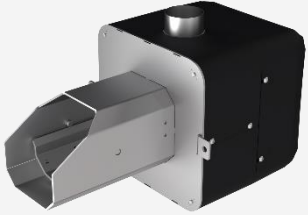

MOTION LINE

SYSTEMS	 M16 - 35 kW	 M50 - 130 kW	 M350 - 500 kW
SINGLE STAGE GRATE SYSTEM	✓	-	-
MULTI-STAGE GRATE SYSTEM	-	✓	-
WALKING GRATE SYSTEM	-	-	✓
INCROX® HIGH-CHROMIUM ALLOY	-	✓	✓
MESH FURNACE SYSTEM	-	✓	✓
FUEL INLET FIREWALL SYSTEM	✓	✓	-
ADJUSTABLE SECONDARY AIR SYSTEM	-	-	✓
CELL FUEL DOSING SYSTEM	-	-	✓
HYBRID DRIVE SYSTEM	✓	✓	✓
OVERPRESSURE COMBUSTION SYSTEM	✓	✓	✓
FUEL MIXING SYSTEM	✓	-	✓
X.BOARD SYSTEM	✓	✓	-
X.SYNC SYSTEM	-	-	✓
X.SHELL SYSTEM	✓	✓	✓
X.GNITE SYSTEM	✓	✓	✓
FIREPROOF CERAMICS	-	✓	✓

FUEL MIXING SYSTEM – Two-stage fuel feeding system. The internal feeder doses the correct amount of biomass into the combustion chamber and also acts as a fuel mixer during the operation of the burner. It optimises the combustion process and extends the maintenance-free operation time of the burner.

OVERPRESSURE COMBUSTION SYSTEM – Reduces the risk of flashback. Through the use of a Venturi tube, the system supplies air centrally to the combustion chamber to increase combustion efficiency and safety. The resulting swirling in the combustion chamber effectively reduces emissions.

FUEL INLET FIREWALL SYSTEM – The fuel inlet to the burner is protected by a barrier with a counterbalance, which closes the fuel inlet opening. In the event of uncontrolled ignition of the fuel in the internal feeder, it cuts off the possibility of fire entering the feeder pipe.

HYBRID DRIVE SYSTEM – This is a combination of a blower fan and an internal feeder drive. This combination results in an optimum ratio of fuel feeding speed to air flow. The main benefits are safety controlled by the fan speed sensor and energy savings due to the use of one motor for two functions.

ROTARY COMBUSTION CHAMBER SYSTEM – Specially developed sequence of furnace rotation means that the fuel bed is in constant motion. This prevents the formation of sinter and the chamber automatically cleans itself of ash during fuel combustion.

AIR VANE SYSTEM – With the use of vanes, we strictly control the air supply method and the amount of air supplied to the combustion chamber, by cutting off the air supply where the air is not involved in the combustion process. As a result, we have achieved unprecedented combustion efficiency and a very low level of waste gas and dust emissions.

FLOATING PIPE SYSTEM – Prevents seizure of the rotary mechanism, extends the life of the burner. The metal of the combustion chamber expands when exposed to high temperatures. The use of this system compensates for the stresses created during the operation of the burner, preventing deformation or damage to burner parts.

InCroX® – It is an extremely durable and reliable high-chromium alloy used to make critical hearth parts in PellasX burners. High-chromium alloy technology guarantees many years of operation without corrosion or wear caused by high temperatures and the aggressive environment of the flue gas.

SINGLE STAGE GRATE SYSTEM – Allows sinter and ash produced during the combustion process to be moved forward, ensuring that the furnace is permanently cleaned during burner operation. Allows efficient combustion of low-quality pellets.

MULTI-STAGE GRATE SYSTEM – It is a sequential furnace with movable sections whose position and method of movement make it possible to effectively clean the furnace of large ashes. With this design of the furnace, it is possible to burn fuels with large amounts of ash, which tends to sinter.

WALKING GRATE SYSTEM – This is another type of movable furnace made of high-chromium InCroX® alloy. The reciprocating movement of the furnace sections is performed individually for each section. With this method, the fuel bed remains in motion while moving in the direction of the waste gas discharge. This movement effectively removes the sinter and ash that forms, without affecting the stability of the combustion process.

MESH FURNACE SYSTEM – The modular design ensures high durability and proper cooling of its components. The components feature an easy assembly system, which facilitates maintenance and cleaning of the space under the burner grate.

FIREPROOF CERAMICS – Elements made of double-reinforced ceramic materials designed for high temperatures. In our burners, their function is to protect the upper part of the furnace and to stabilise the temperature conditions inside.

ADJUSTABLE SECONDARY AIR SYSTEM – The secondary air flow is controlled by means of an adjustable mechanical aperture. This stabilises the conditions in the combustion chamber, which in turn reduces emissions.

CELL FUEL DOSING SYSTEM – The system ensures high accuracy of feeding the fuel to the burner while maintaining a high degree of burner safety - it prevents flashback. It is made of cast iron.

SCRAPER – Made of high-chromium InCroX® alloy, available as an optional extra for R16 and R26 burners. Allows cleaning of the inside of the rotary combustion chamber. Designed to operate under harsh conditions, i.e., burning ash-rich fuels that tend to form sinter.

X.BOARD SYSTEM – Proprietary combination of safety plug and socket with the electrical system in the burner.

X.SYNC SYSTEM – Additional burner controller. Controls burner operation, manages grate operation and controls primary and secondary air supply on M350 and M500 burners.

X.SHELL SYSTEM – Easily removable fan housing with integrated blower duct. Its shape allows the use of the full power range of the blower.

X.GNITE SYSTEM – Easily replaceable, durable and quick igniter.

S.CONTROL CONTROLLERS



The **S.CONTROL** and **S.CONTROL TOUCH** controllers are state-of-the-art devices designed to manage and control the process of pellet combustion in boilers and burners. The controllers use proprietary software based on unique algorithms.

COMFORT OF USE

The controllers feature intuitive and simple operation. The available text and graphic menus allow quick configuration, even of an extensive heating system.

DISPLAY

Two types of display are available: a large and clear monochrome screen and a high-quality colour touchscreen. Graphic and text menus.

BURNER CONFIGURATION WIZARD

A few steps, quick and easy set-up. Automatic adjustment of air-fuel mixture parameters.

ACCESSORIES

The operation of the units can be configured from the wireless room controller or via a web application supported by mobile devices thanks to the Net Control module.



CAPABILITIES AND SPECIFICATIONS OF THE S.CONTROL CONTROLLER

Information:

- Alert and fault log
- Flame brightness readout
- Amount of fuel in the hopper
- Instantaneous fuel consumption rate
- Instantaneous burner power
- Timer with calendar
- Audible alarms
- Quick help info button

Terminals:

- For mixing valves including temperature sensors
- Domestic hot water circulation pump
- Lambda Control – Net Control
- Main hopper feeder incl. fuel sensor
- Pump charging the buffer tank incl. temperature sensors

Inputs/Outputs:

- STB
- Room thermostat
- Boiler thermostat (gas/oil)
- Waste gas temperature sensor
- Central heating pump
- Weather temperature sensor
- Domestic hot water pump including temperature sensor
- Mixing valve including temperature sensor
- Pressure sensor to control waste gas fan

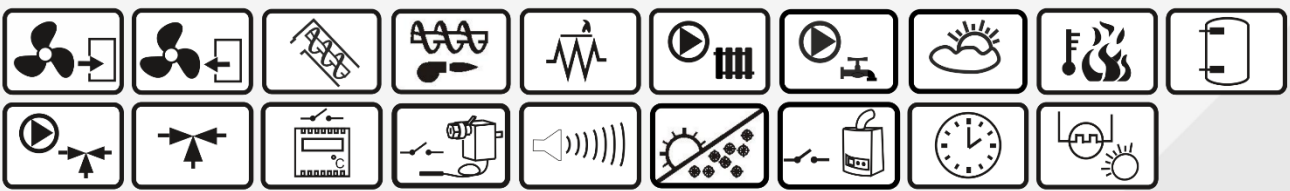

S.CONTROL CONTROLLER EXTENSION OPTIONS

B MODULE

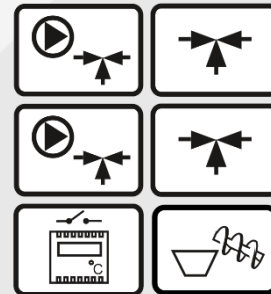
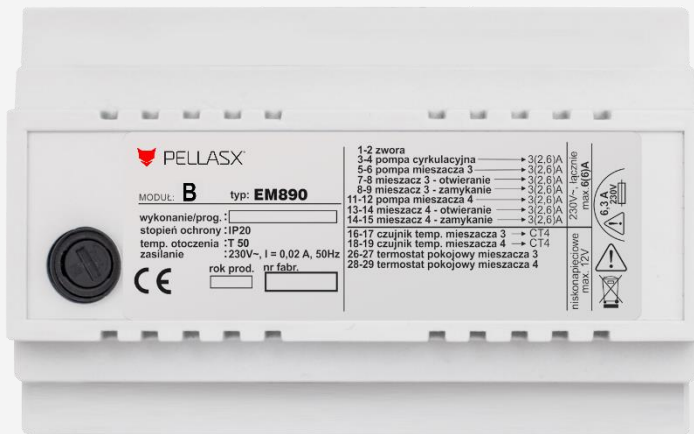

C MODULE

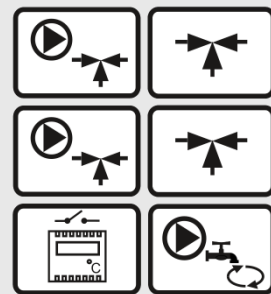
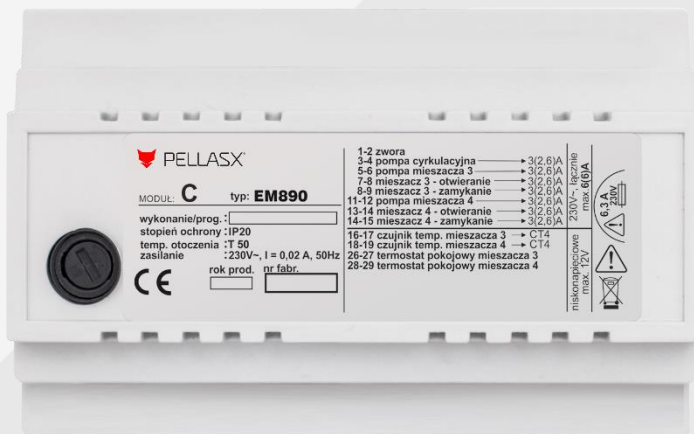

LAUREAT KONKURSU



TERAZ POLSKA

LAUREAT V, VI i VII edycji:

GREENEV

AKCELERATOR ZIELONYCH TECHNOLOGII



PRZEDSIĘBIORSTWO
FAIR PLAY 2018



DISTRIBUTOR

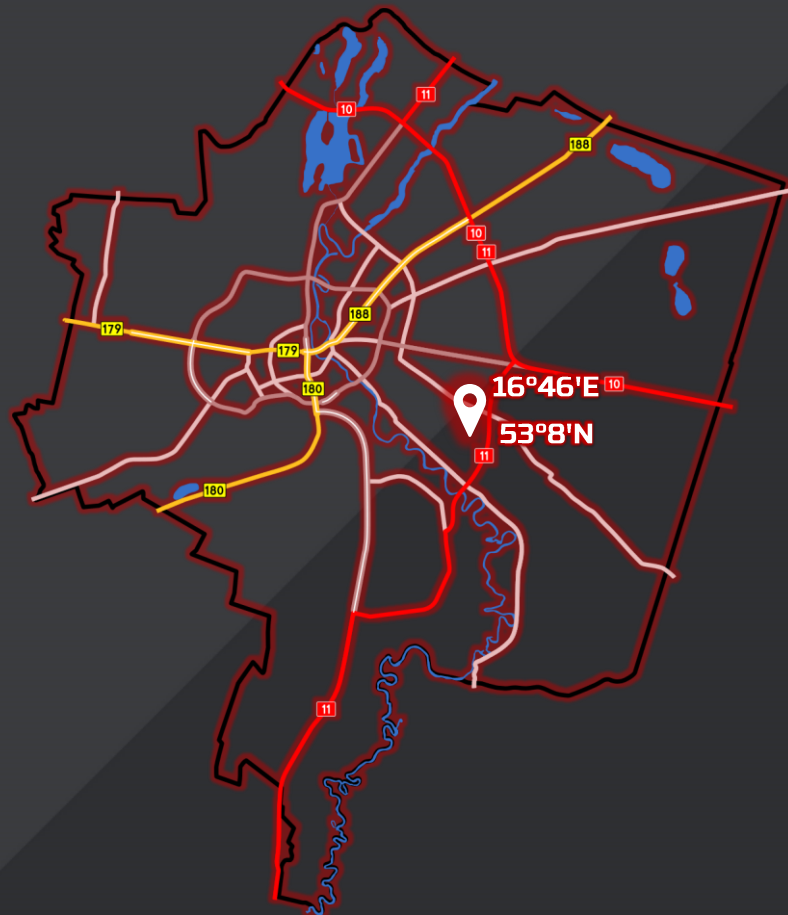

ISOL Sp. z o.o.
Strefowa 5
64-920 Piła, PL
info@pellasx.eu
+ 48 672138040

